



FLEXware™ ACA

(AC Conduit Adapter)

User's Guide

Includes Mounting and Installation



FW-ACA INSTALLATION GUIDELINES AND SAFETY INSTRUCTIONS

This FW-ACA is intended to be installed as part of a permanently grounded electrical system.

Standards and Requirements

All system installations must comply with national (NEC) and local electrical codes; professional installation is recommended.

IMPORTANT SAFETY INSTRUCTIONS

Read all instructions and cautionary markings on the FX, the batteries and all appropriate sections of this installation and user manual as well as other component manuals before using the system.

Be cautious around electricity, electrical components, and batteries. Shocks, burns, injury, and even death can occur if an installer comes in contact with electricity.

An FW-ACA is designed for dry, indoor installation and should not be exposed to water.

Install all components and wiring according to national and local electrical and building codes.

This includes:

- Submitting a plan to the local building department
- Passing inspection

OutBack Power Systems cannot be responsible for system failure, damages, or injury resulting from improper installation of their products.

Contact Information:

OutBack Power Systems
19009 62nd Avenue NE
Arlington, WA USA
(+1) 360-435-6030

European Sales Office
Barcelona, España
(+34) 600-843-845

www.outbackpower.com

FW-ACA

The FLEXware AC Adapter or FW-ACA is a plastic case that fits on the AC end of an FX Series Inverter/Charger to extend the size of the AC wiring compartment in OutBack FLEXware systems. The FW-ACA aligns with knockouts on both the FW500-AC and FW1000-AC enclosures as well as PS2 and PS4 AC enclosures. It's knockouts are not designed for conduit, but can accommodate flexible cables with appropriate strain relief.

Tools Required to Install:

- Phillips screwdriver
- Utility knife
- 4 mm Allen wrench
- Slotted screwdriver

Purpose:

- Remove and install covers
- Scoring and removing plastic knockouts
- Removing and installing FX M5 hex bolts
- Remove/install FX AC Wiring Block wires

Before installing the FW-ACA:

- Remove the plastic cover
- Determine which knockouts should be removed
- Score the knockout(s) with a utility knife and punch/pull the selected knockout(s) until removed

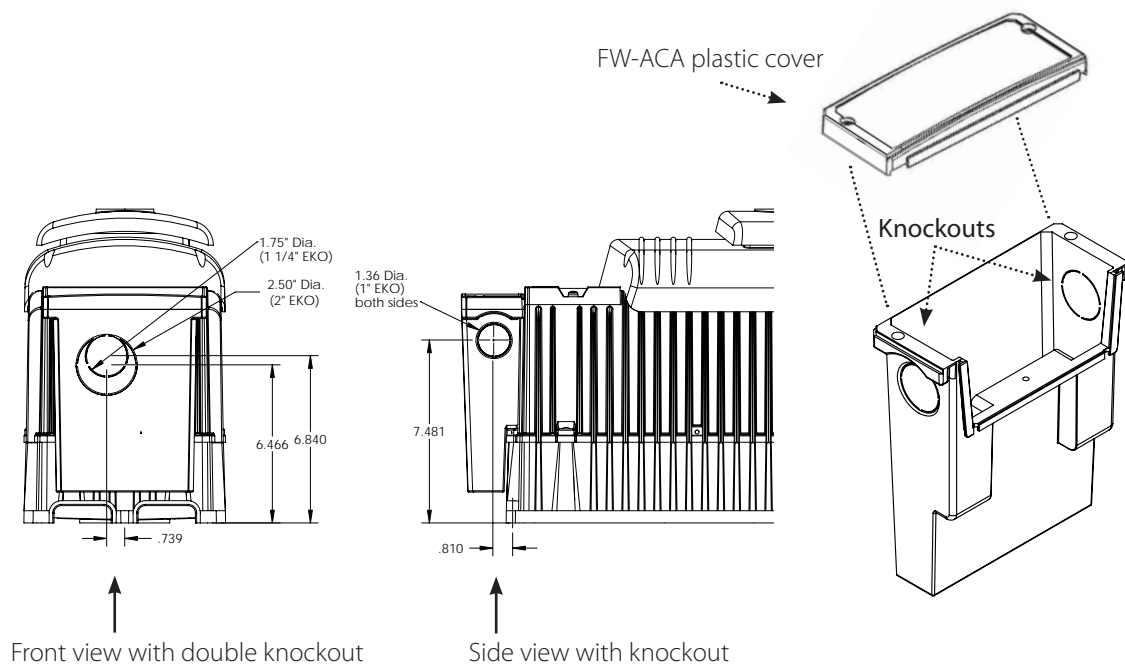
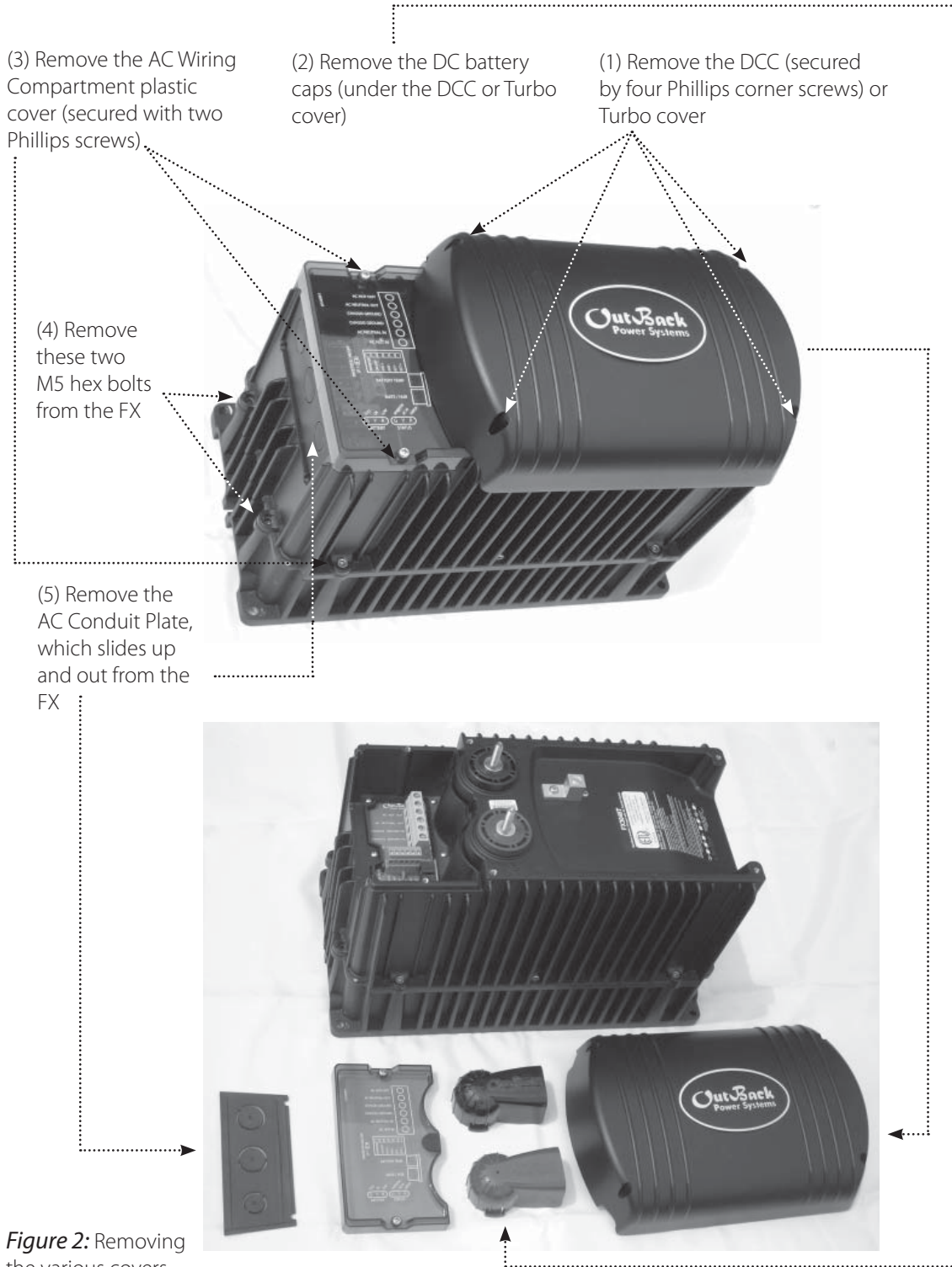
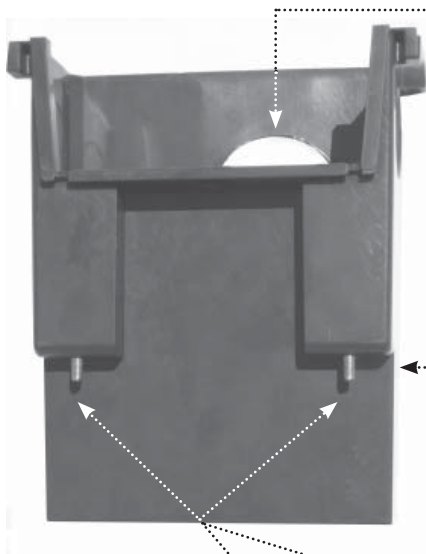

Figure 1: FW-ACA

PROCEDURE

Turn off the system's DC, AC IN, and AC OUT breakers (if available, use BYPASS mode to power any loads).





Chosen knockout(s) should be removed before installing the FW-ACA

(6) Remove any AC wires from the FX AC Wiring Block by loosening the slotted screws. These wires will be installed through the FW-ACA.

(7) The FW-ACA slides onto the FX in the same location as the now removed AC Conduit Plate and secures to the FX with its own factory-supplied screws in the same location as the removed M5 hex bolts.

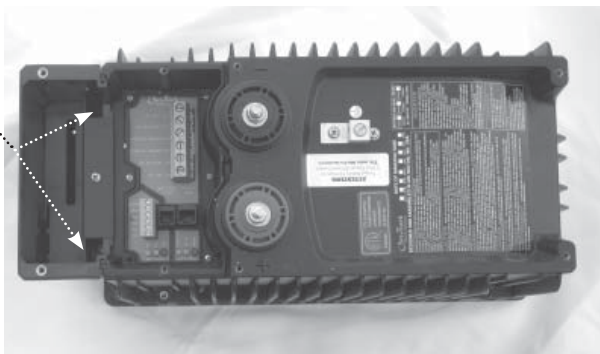
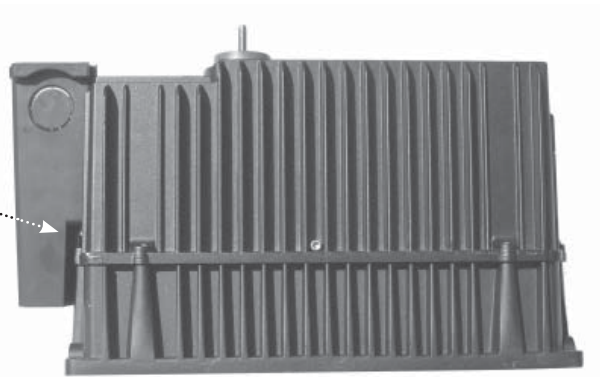

(8) When an FW-ACA is installed in an AC enclosure, insert a bushing (it is not critical that this bushing line up precisely with the FW-ACA); if flexible cable is used instead of an enclosure, appropriate strain relief is required.

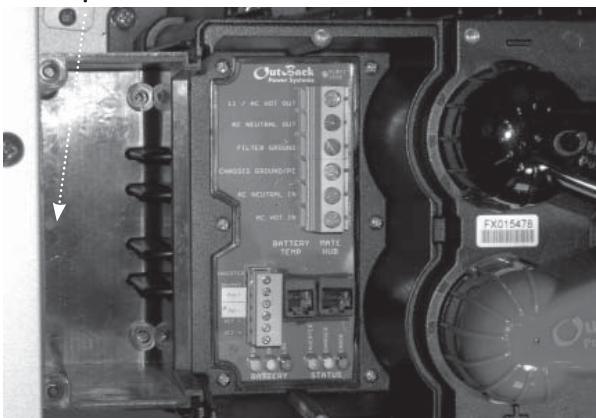

Figure 3: FW-ACA installed on an FX

(9) With the FW-ACA secured to the FX, connect all power wires and other cables including:

- MATE
- HUB
- Battery Temp Sensor
- AUX

With all cables and DC battery caps attached, install the protective covers in this order:

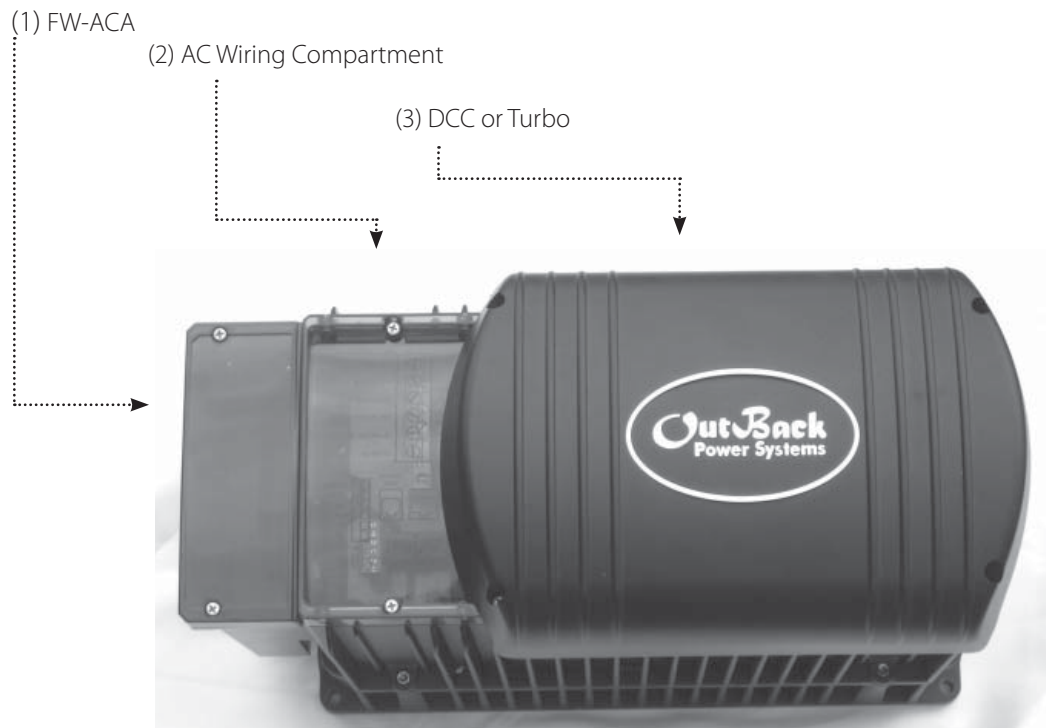

Figure 4: FW-ACA and various covers installed

WARRANTY

OutBack Power Systems Two Year Limited Warranty

OutBack Power Systems Inc. warrants that the products it manufactures will be free from defects in materials and workmanship for a period of two (2) years subject to the conditions set forth below.

The limited warranty is extended to the original user and is transferable. The limited warranty term begins on the date of invoice to the original user of the product. The limited warranty does not apply to any product or part thereof damaged by a) alteration or disassembly, b) accident or abuse, c) corrosion, d) lightning, e) reverse polarity, f) repair or service provided by an unauthorized repair facility, g) operation or installation contrary to instructions pertaining to the product.

OutBack Power Systems' liability for any defective product or any part thereof shall be limited to the repair or replacement of the product, at OutBack Power Systems' discretion. OutBack Power Systems does not warrant or guarantee the workmanship performed by any person or firm installing its products.

THIS LIMITED WARRANTY GIVES YOU SPECIFIC LEGAL RIGHTS, AND YOU MAY ALSO HAVE OTHER RIGHTS THAT VARY FROM STATE TO STATE (OR JURISDICTION TO JURISDICTION). OUTBACK POWER SYSTEMS' RESPONSIBILITY FOR MALFUNCTIONS AND DEFECTS IN HARDWARE IS LIMITED TO REPAIR AND REPLACEMENT AS SET FORTH IN THIS LIMITED WARRANTY STATEMENT. ALL EXPRESS AND IMPLIED WARRANTIES FOR THE PRODUCT, INCLUDING BUT NOT LIMITED TO ANY IMPLIED WARRANTIES OF AND CONDITIONS OF MERCHANTABILITY AND FITNESS FOR A PARTICULAR PURPOSE, ARE LIMITED IN DURATION TO THE LIMITED WARRANTY PERIOD SET FORTH ABOVE AND NO WARRANTIES, WHETHER EXPRESS OR IMPLIED, WILL APPLY AFTER SUCH PERIOD. SOME STATES (OR JURISDICTIONS) DO NOT ALLOW LIMITATIONS ON HOW LONG AN IMPLIED WARRANTY LASTS, SO THE ABOVE LIMITATION MAY NOT APPLY TO YOU.

OUTBACK POWER SYSTEMS DOES NOT ACCEPT LIABILITY BEYOND THE REMEDIES SET FORTH IN THIS LIMITED WARRANTY STATEMENT OR LIABILITY FOR INCIDENTAL OR CONSEQUENTIAL DAMAGES, INCLUDING WITHOUT LIMITATION ANY LIABILITY FOR PRODUCTS NOT BEING AVAILABLE FOR USE. SOME STATES (OR JURISDICTIONS) DO NOT ALLOW THE EXCLUSION OR LIMITATION OF INCIDENTAL OR CONSEQUENTIAL DAMAGES, SO THE ABOVE EXCLUSION OR LIMITATION MAY NOT APPLY TO YOU.

During the two year period beginning on the invoice date, OutBack Power Systems will repair or replace products covered under this limited warranty that are returned to OutBack Power Systems' facility or to an OutBack Power Systems authorized repair facility, or that are repaired on site by an OutBack Power Systems authorized repair technician. To request limited warranty service, you must contact OutBack Power Systems at 360-435-6030 within the limited warranty period. If limited warranty service is required, OutBack Power Systems will issue a Return Material Authorization (RMA) Number. Mark the outside of the package with the RMA number and include a copy of the purchase invoice in the package. You must ship the products back to OutBack Power Systems in their original or equivalent packaging, prepay shipping charges, and insure the shipment or accept the risk of loss or damage during shipment. OutBack Power Systems will ship the repaired or replacement products to you freight prepaid if you use an address in the continental United States, where applicable. Shipments to other locations will be made freight collect.

PRODUCT REGISTRATION

Your purchase of an OutBack Power Systems product is an important investment. Registering your products will help us maintain the standard of excellence you expect from us in terms of performance, quality and reliability.

Please take a moment to register and provide us with some important information.

NAME: _____	E-MAIL: _____
ADDRESS: _____	SOLD BY: _____
CITY: _____	INSTALLER: _____
STATE: _____ ZIP CODE: _____	PURCHASE DATE: _____
COUNTRY: _____	MODEL NUMBER: _____
TELEPHONE NUMBER: _____	SERIAL NUMBER: _____

Send your Product Registration to:

OutBack Power Systems
19009 62nd Ave NE
Arlington, WA 98223 USA



19009 62nd Avenue NE
Arlington, WA USA
(+1) 360-435-6030

European Sales Office
Barcelona, España
(+34) 600-843-845

www.outbackpower.com

900-0090-01-00 REV A